

Electron Multiplying CCD Camera

ImagEM^{X2} series

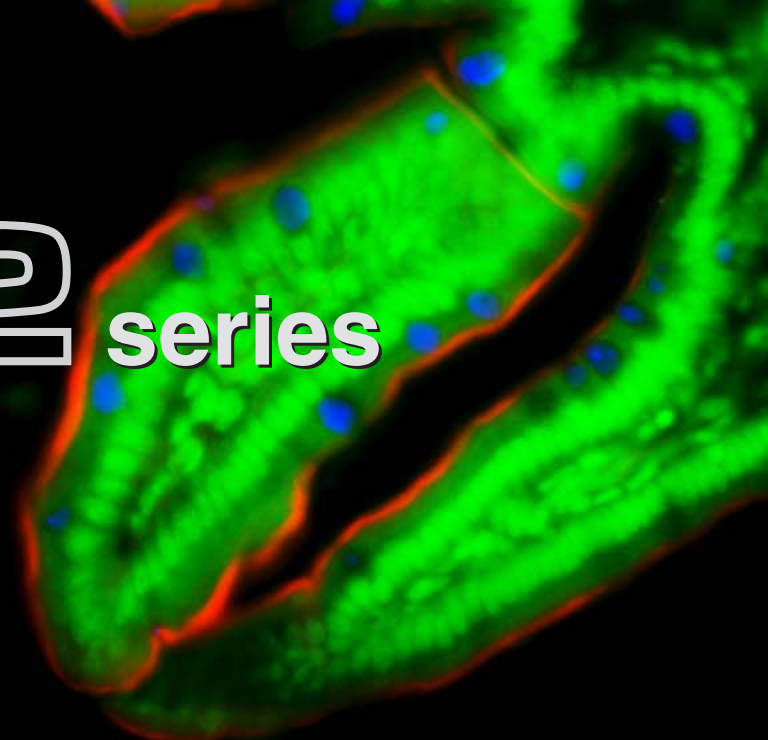

Multiply faster

The ImagEM[®] X2 is an extremely versatile camera that quietly delivers 70 frames/s at full frame and up to 1076 frames/s with analog binning and regions of interest. With very high signal to noise in near dark conditions and extremely low dark current, the ImagEM X2 enables quantitative ultra-low light imaging both for long integration times and at high speed. With EM gain off, the extremely deep full well capacity can extract information from the lowest contrast bright images. Additional new features allow for optimized camera triggering, on-board for EM gain protection, streamlined connectivity through IEEE1394b, improved overall signal to noise and increased non-EM dynamic range. Hamamatsu has taken the beloved 512 × 512 EM-CCD sensor and created a masterfully redesigned camera that delivers maximum speed and precision performance. The ImagEM X2-1K 1024 × 1024 version is also available.

High-speed readout (ImagEM X2)

70 frames/s

at full resolution

1076 frames/s

at Sub-array16 pixel, 4×4 binning



HAMAMATSU
PHOTON IS OUR BUSINESS

Hungry for Photons

With large pixels, high QE, and relatively zero readout noise, EM-CCD technology performs in low light conditions. How low light? When you've got fewer than 10 photons per pixel between the sample and background, EM-CCDs are the perfect tool for the job, delivering the best SNR of any camera technology. For high mag, biologically relevant applications with routine exposure times of 10 ms to 30 ms, the sample is likely emitting hundreds to thousands of photons per pixel. But with faster speeds come shorter exposure times, risking the ability to capture more than tens of photons per pixel in one shot and therefore pushing the application into the ultra-low light zone.

The ImagEM X2 series makes these super-fast exposures possible and has the sensitivity to provide visually pleasing and quantitatively meaningful images in a photon-starved environment.

New Features

Faster readout

By clocking pixel readout at 22 MHz, the ImagEM X2 is able to achieve 70.4 frames/s with full frame resolution. That's more than 2x the original ImagEM and is faster than any commercially available camera using the sensor. The ImagEM X2-1K is able to run 18.5 frames/s with full frame resolution.

ImagEM X2 (Clock: 22 MHz)

Binning	Sub-array (Effective vertical width)					
	512	256	128	64	32	16
1 × 1	70.4	133	241	405	613	820
2 × 2	131	238	400	606	813	981
4 × 4	231	389	588	794	962	1076

(Unit: frames/s)

ImagEM X2-1K (Clock: 22 MHz)

Binning	Sub-array (Effective vertical width)						
	1024	512	256	128	64	32	16
1 × 1	18.5	34.9	62.7	104	156	208	249
2 × 2	34.7	62.5	104	155	207	248	275
4 × 4	61.8	102	154	205	245	272	288

(Unit: frames/s)

Corner readout

By selectively imaging at the edge of the sensor, closest to the read register of the chip, it is possible to achieve even greater speeds of small ROIs.

ImagEM X2 (Clock: 22 MHz)

Binning	Sub-array					
	512x512	256x256	128x128	64x64	32x32	16x16
1 × 1	70.4	133	285	495	741	893
2 × 2	131	238	456	699	901	981
4 × 4	231	389	645	863	981	1076

(Unit: frames/s)

ImagEM X2-1K (Clock: 22 MHz)

Binning	Sub-array						
	1024x1024	512x512	256x256	128x128	64x64	32x32	16x16
1 × 1	18.5	34.9	79.5	161	237	237	298
2 × 2	34.7	62.5	126	215	274	274	307
4 × 4	61.8	102	179	256	293	293	305

(Unit: frames/s)

Lower readout noise

In any image sensor, faster readout means increased readout noise. Yet readout noise is considered irrelevant for EM-CCDs because of the EM gain. The ImagEM X2 series even before applying EM gain, has fast speed and low readout noise. But didn't we just say readout noise in EM-CCD was irrelevant? Yes, in SNR equations this is true. However, if the primary purpose of EM gain is to overcome readout noise, then this will be accomplished with less gain in the ImagEM X2 series and less voltage in the EM register, translating into theoretically more stable EM gain calibrations and greater sensor longevity.

Type number			ImagEM X2(C9100-23B)	ImagEM X2-1K(C9100-24B)
Readout noise (rms) (typ.)	EM-CCD readout	EM gain	36 electrons (at 22 MHz)	15 electrons (at 22 MHz)
		4x	25 electrons (at 11 MHz)	10 electrons (at 11 MHz)
		8 electrons (at 0.6875 MHz)	3 electrons (at 0.6875 MHz)	
	NORMAL CCD readout	8 electrons (at 0.6875 MHz)	3 electrons (at 0.6875 MHz)	
		EM gain 1200x	1 electron max.	

Mechanical shutter

The ImagEM X2 series includes an integrated mechanical shutter in order to protect the camera from EM gain degradation and to lessen afterimage effects. The mechanical shutter is software controlled.

EM gain measurement and calibration

Gain aging is a known and expected process in EM technology. Even when every care is taken to minimize gain aging, use of the camera in EM mode, especially with high gains or high intensity light, can degrade the gain. Since this is a use-dependent phenomenon, it's important to know when it's happened and to have the ability to easily recalibrate. These two functions in the ImagEM X2 series make this crucial maintenance of the camera software accessible and user friendly.

IEEE 1394b connectivity

The data rates of the ImagEM X2 series are well suited to the trusted and easy to use 1394b connectivity.

SMA triggering ports

In its new incarnation, the ImagEM X2 series sports four shiny and compact SMA ports, one for input of an external trigger and three for output to other devices. These ports can be used to access an array of triggering options including three additional features: programmable trigger input/output, trigger delay and trigger ready. There is no denying that EM-CCD technology offers the best SNR for ultra-low light imaging, and the ImagEM X2 offers the fastest speeds combined with multiple engineering enhancements to allow you to make the most of this technology.

Direct electron display

Output signal can be indicated in "electrons" instead of pixel AD counts in application software.

Black clip / White clip function

It enables setting an upper or lower threshold of intensity. If there is a brighter or darker location than a sample of interest in an image, this function allows clipping the upper limit or lower limit of intensity to make Auto LUT function work effectively.

Cooling status output

The camera indicates when it has reached the target cooling temperature.

Applications

- Protein-protein interaction
- Calcium waves in cell networks and intracellular ion flux
- Real time spinning disk confocal microscopy
- Single molecule imaging with TIRF microscopy
- Fluorescence in-vivo blood cell microscopy
- Gene expression imaging using luminescence

Image example: Real time confocal imaging

Fast imaging of mouse brain cell with Cy3 imaged with confocal scanner unit

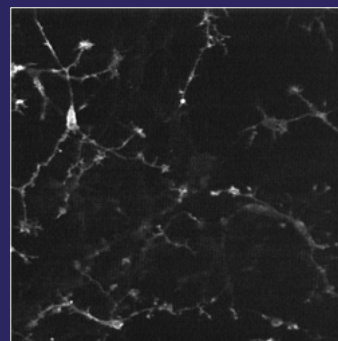

- EM gain: 150x
- Exposure time: 10 ms
- Effective number of pixels: 512x512
- Binning: 1x1
- Objective lens: 40x
- Confocal unit: CSU-W1
- Excitation laser: 561 nm

High Sensitivity

High QE

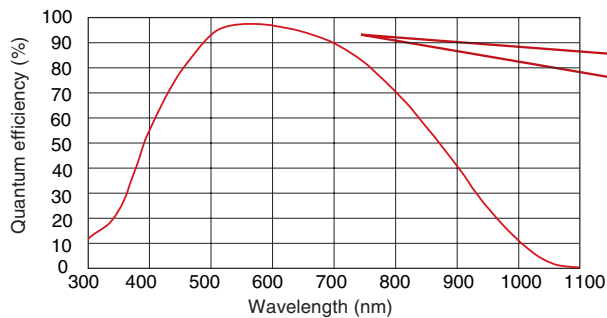

The beloved EM-CCD sensor provides over 90 % peak QE.

High EM gain of maximum 1200x

EM gain feature is ideal for live cell imaging because of shorter exposure times and reduced excitation light levels.

- Comparison of sensitivity with conventional camera: Luminescence imaging of HeLa cells expressing Renilla Luciferase.

Conventional cooled CCD camera



ImagEM X2



Low Noise

Minimal dark noise is another benefit of stable cooling performance

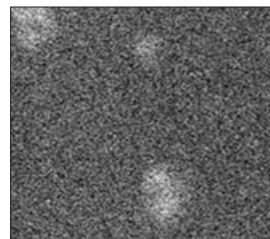
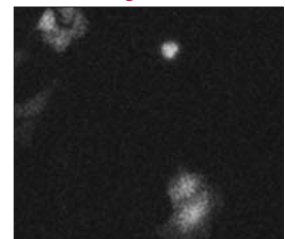
The dark current of a CCD depends on the temperature, and it decreases by half when the temperature drops by approximately 7 to 8 °C. Therefore, cooling a CCD is a very good way to reduce dark current noise.

The ImagEM X2 series's stable cooling enables stable output and its water cooling minimizes dark current.

Highly stabilized control of sensor temperature with either water or forced-air cooling

Water or forced-air cooling is selectable for any application, and optimal cooling temperature can be set in each cooling mode.

Optimized sensor drive methods significantly reduce the clock induced charge (CIC)

Dark current consists of thermal charge and clock induced charge (CIC). CIC will dominate the dark charge in the images taken at short exposure time, and thermal charge will dominate the dark charge in images taken at longer exposures. The camera is adjusted to use the optimized drive method suitable to the scan speed. The biologist doesn't have to think about CIC optimization for long or short exposures. The camera handles it automatically.

- Comparison of noise: Comparison of two clock induced charge images

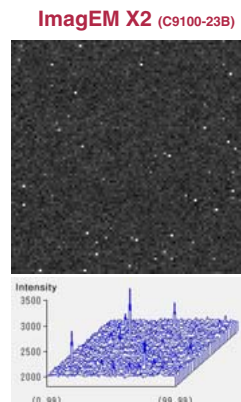
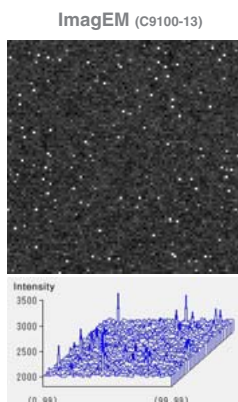

Intensity profile

(EM gain: 1200x, Exposure time: 30 ms, no light, enlarged 100 x 100 pixel region)

Great Stability

Highly stabilized EM gain by cooling temperature control

Maintaining stable cooling temperature is essential to stable gain settings required for superior performance in long duration imaging and analysis. Very precise control of the cooling temperature in the ImagEM X2 series is a key benefit.

Examples of temperature stability and EM gain stability

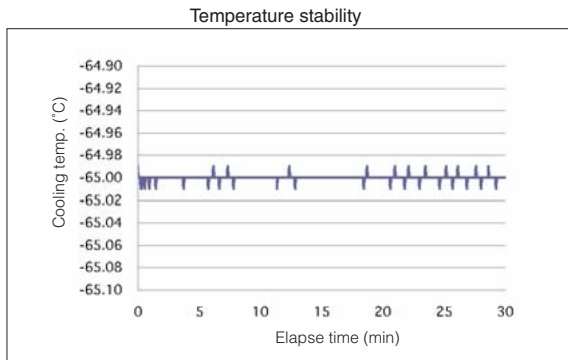

- Temperature stability: ± 0.01 °C
- Camera: C9100-23B
- Clock: 22 MHz
- Cooling temperature: -65 °C
- Air cool, Ambient temperature: +20 °C

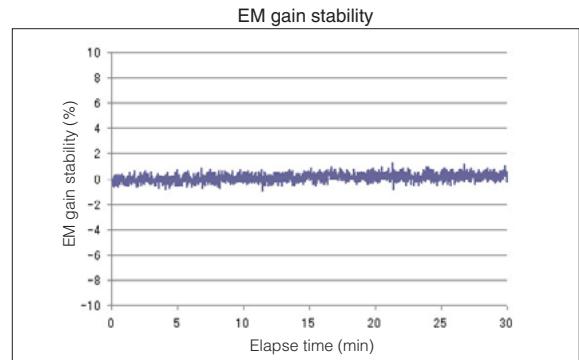

- EM gain stability: ± 1 %
- Camera: C9100-23B
- Clock: 22 MHz
- Cooling temperature: -65 °C
- Air cool, Ambient temperature: +20 °C

Stability of mean bias value (Digitizer offset)

The baseline is constant over time providing signal stability for long term measurements.

Example of baseline variance

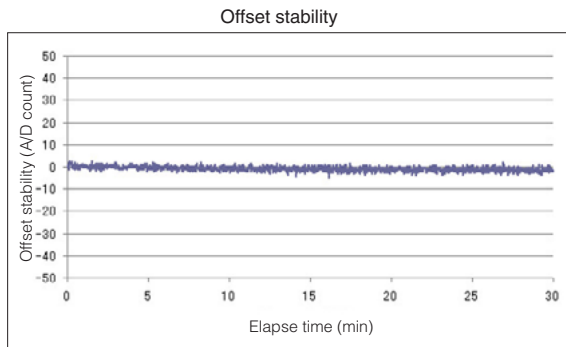

- Camera: C9100-23B
- Cooling method: Air cooled
- Clock: 22 MHz
- EM gain: 4x
- Exposure time: 13.93 ms
- No light

EM gain protection

It is important to operate the camera in ways that minimize the rate of gain aging and extend the life of the camera. The ImagEM X2 protects EM gain in two levels: EM gain warning and EM gain protection. EM gain protection mode stops charge transfer through the EM gain register when excessive output conditions have occurred which may damage the sensor.

EM gain readjustment *

Over time all EM-CCD cameras exhibit gain degradation. The EM gain can be readjusted by raising the voltage in the multiplying register. The EM gain readjustment can be done by software which comes with the camera. However, the number of times the EM gain can be readjusted is limited.

*This feature is available when the camera is operated with DCAM-API. (DCAM-API is a software driver which supports HAMAMATSU digital cameras.)

Selectable Readout Modes

Select a readout mode for optimal image acquisition based on the sample brightness or desired frame rate or exposure time.

EM-CCD readout

For short exposure, high sensitivity imaging

■ Sample of EM-CCD readout

Confocal calcium ion imaging of HeLa cells expressing yellow Chameleon 3.6. This image shows changes of histamine stimulated calcium ion with two Z positions and four time lapse.

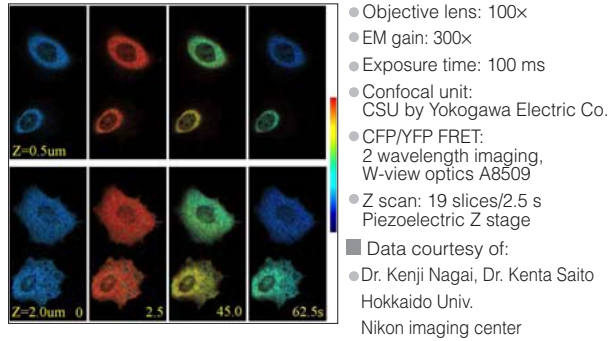

Normal-CCD readout

For high dynamic range imaging

■ Sample of Normal-CCD readout

Luminescence imaging of HeLa cells expressing Renilla Luciferase.

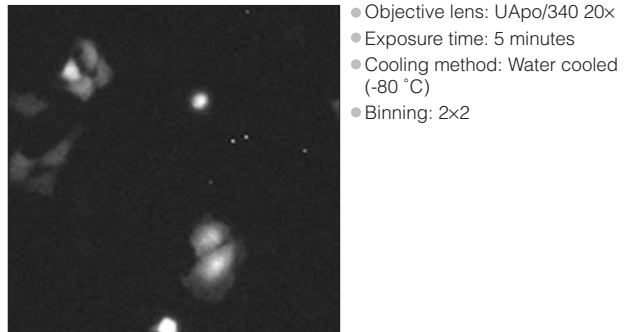

An often overlooked benefit of EM-CCD technology is the ability to utilize the camera as a standard CCD. In non-EM mode, there is no effect of excess noise, and the large full well capacity and high dynamic range are ideal for bright light applications that have large intrascene dynamic range. The Imagem X2 series provides a low read noise non-EM mode that can be an ideal choice for such applications.

Photon Imaging Mode

This is a unique technology to improve image quality at very low light level to overcome the limitation of excess noise factor from the electron multiplying process. This mode is most useful for signal levels at which maximum EM gain has no apparent signal or very little signal. The mode preserves quantitative linear signal output and also improves spatial resolution at very low light levels.

■ Sample of photon imaging mode

Fluorescence beads imaged with reduced excitation light intensity.

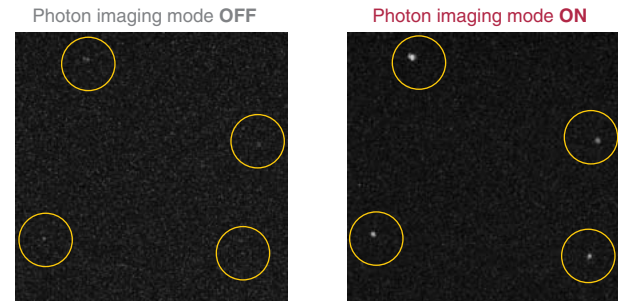

(Exposure time: 30.5 ms, EM gain: 1200x)

On-board Image Processing

The following real time processing functions are available.

- **Background subtraction**
Effective for reducing fluorescence in image backgrounds.
- **Shading correction**
This feature corrects the shading or uneven illumination in microscope images or other illumination systems.
- **Recursive filter**
This feature provides random noise elimination in an image by weighted time based averaging.
- **Frame averaging**
This feature provides noise elimination in an image by simple frame averaging and less "afterimage" effect than the recursive filter.
- **Spot noise reducer**
This image processing function operates on random spots of intensity by comparing incoming images and eliminating signals that meet the criteria for noise in one image but not in others. This processing eliminates noise elements like cosmic rays.

Specifications

Type number	C9100-23B(ImagEM X2)		C9100-24B(ImagEM X2-1K)	
Camera head type	Hermetic vacuum-sealed air/water-cooled head *1			
Window	Anti-reflection (AR) coatings on both sides, single window			
AR mask	Yes	No		
Imaging device	Electron Multiplying Back-Thinned Frame Transfer CCD			
Effective number of pixels	512 (H) × 512 (V)		1024 (H) × 1024 (V)	
Cell size	16 μm (H) × 16 μm (V)		13 μm (H) × 13 μm (V)	
Effective area	8.19 mm (H) × 8.19 mm (V)		13.3 mm (H) × 13.3 mm (V)	
Pixel clock rate	EM-CCD readout	22 MHz, 11 MHz, 0.6875 MHz		
	Normal-CCD readout	0.6875 MHz		
EM (electron multiplying) gain (typ.) *2	1x, 4x to 1200x		1x, 10x to 1200x	
Ultra-low light detection	Photon Imaging mode (1, 2, 3)			
Fastest readout speed	70.4 frames/s to 1076 frames/s		18.5 frames/s to 314 frames/s*3	
Readout noise (rms) (typ.)	EM-CCD readout	EM gain 4x	36 electrons (at 22 MHz)	15 electrons (at 22 MHz)
			25 electrons (at 11 MHz)	10 electrons (at 11 MHz)
			8 electrons (at 0.6875 MHz)	3 electrons (at 0.6875 MHz)
		EM gain 1200x	1 electron max.	
Full well capacity (typ.)	EM-CCD mode	370 000 electrons		400 000 electrons
	Normal-CCD mode	140 000 electrons		50 000 electrons
Analog gain *4	EM-CCD readout	22 MHz	1x	
		11 MHz/0.6875 MHz	0.5x, 1x	
	Normal CCD readout	1x, 2x, 3x, 4x, 5x		
Cooling method / temperature *5	Forced-air cooled	at temperature control (Room temperature: 0 °C to +30 °C)	-65 °C	
		at maximum cooling typ.	-80 °C (Room temperature: Stable at +20 °C)	
	Water cooled *6	at temperature control (Water temperature: +20 °C)	-80 °C	
		at maximum cooling typ.	-100 °C (Water temperature: lower than +10 °C)	
Temperature stability (typ.)	±0.01 °C			
Dark current (typ.) *7	Forced-air cooled (-65 °C)	0.005 electron/pixel/s		0.01 electron/pixel/s
	Water cooled (-80 °C)	0.0005 electron/pixel/s		0.001 electron/pixel/s
Clock induced charge (typ.)	0.0015 events/pixel/frame		0.01 events/pixel/frame	
Exposure time *8	Internal synchronous mode	13.9 ms to 1 s (22 MHz)		52.7 ms to 1 s (22 MHz)
		27.2 ms to 2 h (11 MHz)		103.2 ms to 2 h (11 MHz)
		421.5 ms to 2 h (0.6875 MHz)		1616.9 ms to 2 h (0.6875 MHz)
	External trigger mode	10 μs to 1 s (22 MHz)		
A/D converter	16 bit			
Output signal / External control	IEEE 1394b			
Sub-array	Every 16 lines (horizontal, vertical) size, position can be set			
Binning	2×2, 4×4, 8×8, 16×16 *9		2×2, 4×4	
External trigger mode*10	Edge trigger, Level trigger, Start trigger, Synchronous readout trigger			
Trigger output *10	Exposure timing output, Programmable timing output (Delay and pulse length are variable.), Trigger ready output			
Image processing features (real-time)	Background subtraction, Shading correction, Recursive filter, Frame averaging, Spot noise reducer*11			
EM gain protection	EM warning mode, EM protection mode			
EM gain readjustment	Available			
Lens mount	C-mount			
Power requirements	AC 100 V to 240 V, 50 Hz / 60 Hz			
Power consumption	Approx. 140 VA			
Ambient storage temperature	-10 °C to + 50 °C			
Ambient operating temperature	0 °C to + 40 °C			
Performance guaranteed temperature	0 °C to + 30 °C			
Ambient operating humidity	70 % max. (with no condensation)			

*1 The hermetic sealed head maintains a high degree of vacuum, 10⁻⁸ Torr, without re-evacuation.

*2 Even with electron multiplying gain maximum, dark signal is kept at a low level during low light imaging.

*3 At 4×4 binning and 64×16 Sub-array

*4 Linearity is not assured when full well capacity is over 370 000 electrons and 400 000 electrons, because of CCD performance.

*5 The cooling temperature may not reach to this temperature; it depends on the operation condition.

*6 Water volume 0.5 liter/min.

*7 Typical thermal charge value (not guaranteed).

*8 Image smearing may appear when the exposure time is short.

*9 8 × 8 and 16 × 16 binning are available on special order. Please consult with our sales office.

*10 C-MOS 3.3 V with reversible polarity.

*11 Recursive filter, frame averaging, and spot noise reducer cannot be used simultaneously.

→ Configuration example

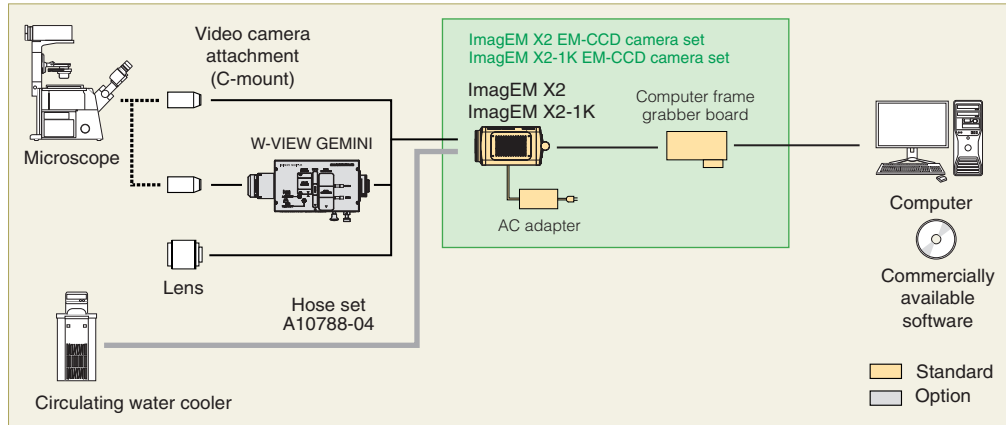

*Please contact your local Hamamatsu representative or distributor regarding actual configuration.

→ Dimensional outlines

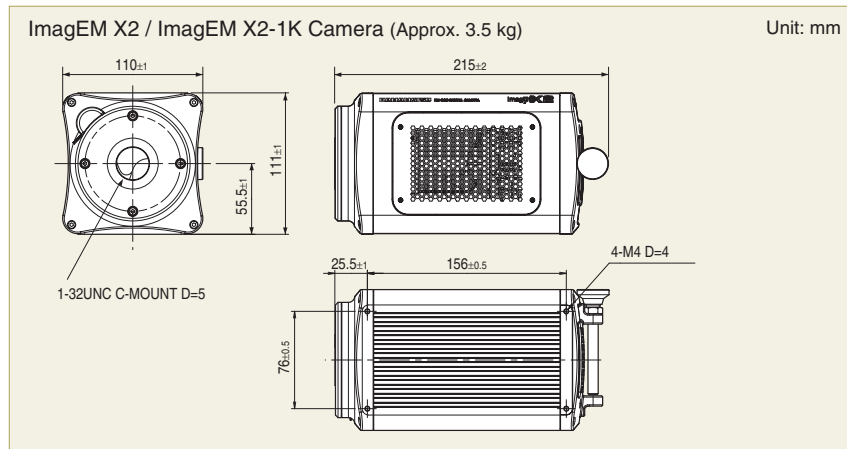

→ Options

- Binning option: M10354-03 (ImagEM X2)
- SMA-BNC cable: A12106-05
- SMA-SMA cable: A12107-05
- Hose set: A10788-04
- ImagEM X2 baseplate: A12263-01
- W-VIEW GEMINI: A12801-01



Image splitting optics

W-VIEW GEMINI A12801-01 (Option)

The W-VIEW GEMINI is an image splitting optics which provides one pair of dual wavelength images separated by a dichroic mirror onto a single camera. Simultaneous image acquisition of dual wavelength images allows you high speed ratio metric imaging and other multiple fluorescence applications.

ImagEM is registered trademark of Hamamatsu Photonics K.K. (EU, Japan, U.K., U.S.A.)

Product and software package names noted in this documentation are trademarks or registered trademarks of their respective manufacturers.

● Subject to local technical requirements and regulations, availability of products included in this promotional material may vary. Please consult your local sales representative.

● Information furnished by HAMAMATSU is believed to be reliable. However, no responsibility is assumed for possible inaccuracies or omissions.

Specifications and external appearance are subject to change without notice.

© 2014 Hamamatsu Photonics K.K.

HAMAMATSU PHOTONICS K.K. www.hamamatsu.com

HAMAMATSU PHOTONICS K.K., Systems Division

812 Joko-cho, Higashi-ku, Hamamatsu City, 431-3196, Japan, Telephone: (81)53-431-0124, Fax: (81)53-435-1574, E-mail: export@sys.hpk.co.jp

U.S.A.: Hamamatsu Corporation: 360 Foothill Road, Bridgewater, N.J 08807, U.S.A., Telephone: (1)908-231-0960, Fax: (1)908-231-1218 E-mail: usa@hamamatsu.com

Germany: Hamamatsu Photonics Deutschland GmbH.: Arzbergerstr. 10, D-82211 Herrsching am Ammersee, Germany, Telephone: (49)8152-375-0, Fax: (49)8152-265-8 E-mail: info@hamamatsu.de

France: Hamamatsu Photonics France S.A.R.L.: 19, Rue du Saule Trapu, Parc du Moulin de Massy, 91882 Massy Cedex, France, Telephone: (33)1 69 53 71 00, Fax: (33)1 69 53 71 10 E-mail: infos@hamamatsu.fr

United Kingdom: Hamamatsu Photonics UK Limited: 2 Howard Court, 10 Tewin Road, Welwyn Garden City, Hertfordshire AL7 1BW, UK, Telephone: (44)1707-294888, Fax: (44)1707-325777 E-mail: info@hamamatsu.co.uk

North Europe: Hamamatsu Photonics Norden AB: Torshamnsgatan 35 16440 Kista, Sweden, Telephone: (46)8-509-031-00, Fax: (46)8-509-031-01 E-mail: info@hamamatsu.se

Italy: Hamamatsu Photonics Italia S.r.l.: Strada della Moia, 1 int. 6 20020 Arese (Milano), Italy, Telephone: (39)02-93581733, Fax: (39)02-93581741 E-mail: info@hamamatsu.it

China: Hamamatsu Photonics (China) Co., Ltd.: B1201 Jiaming Center, No.27 Dongsanhuan Beilu, Chaoyang District, Beijing 100020, China, Telephone: (86)10-6586-6006, Fax: (86)10-6586-2866 E-mail: hpc@hamamatsu.com.cn

Cat. No. SCAS0092E03

SEP/2014 HPK

Created in Japan